

Positioning system E 40, 60, 60S, 80, 80S

Roller guide unit without drive

Specifications

2.1

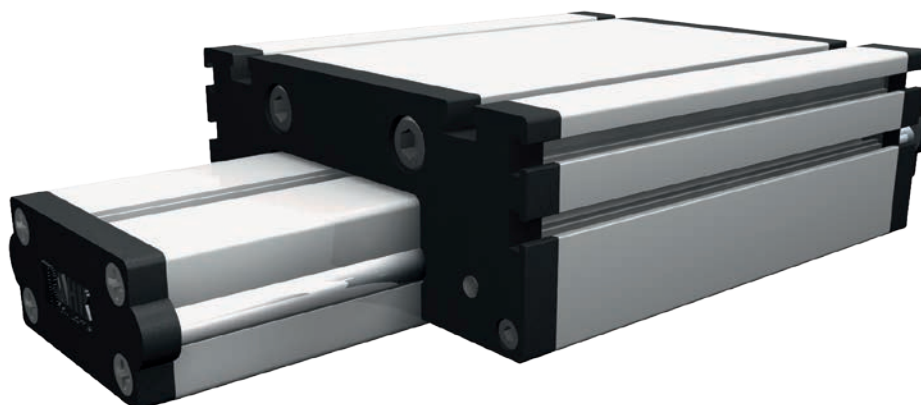

Function:

Very low building system achieved by an aluminium guide body with integrated, hardened steel guide rods. The carriage, which has internal linear ball bearings that can be adjusted free of play, moves along the body.

Fitting position: As required, max. length 6.000 mm.

Carriage connection: By T-slots.

Unit mounting: By tapped holes in the mounting surface, bottom surface with T-slots.

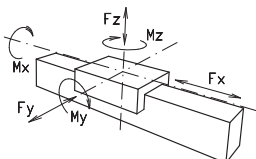
Forces and torques	Size	E 40		E 60		E 60 S		E 80		E 80S	
	Forces/Torques	static	dynamic	static	dynamic	static	dynamic	static	dynamic	static	dynamic
	F_x (N)	-	-	-	-	-	-	-	-	-	-
	F_y (N)	1200	700	3000	2000	4100	3100	3000	2000	4600	3600
	F_z (N)	900	650	1700	1100	2160	1600	1700	1100	3000	1800
	M_x (Nm)	25	20	67	43	88	65	90	55	170	140
	M_y (Nm)	32	18	90	70	190	140	110	80	270	230
	M_z (Nm)	35	25	120	100	230	170	150	120	300	220
All forces and torques relate to the following:											
existing values $\frac{F_y}{F_{y_{dyn}}} + \frac{F_z}{F_{z_{dyn}}} + \frac{M_x}{M_{x_{dyn}}} + \frac{M_y}{M_{y_{dyn}}} + \frac{M_z}{M_{z_{dyn}}} \leq 1$											
table values											
Speed											
max. (m/s)											
4 5 5 6 8											
Geometrical moments of inertia of aluminium profile											
I_x mm ⁴											
0,157x10 ⁵ 1,71x10 ⁵ 1,71x10 ⁵ 2,8x10 ⁵ 2,8x10 ⁵											
I_y mm ⁴											
0,654x10 ⁵ 6,1x10 ⁵ 6,1x10 ⁵ 10,59x10 ⁵ 10,59x10 ⁵											
E-Modulus N/mm ²											
70000 70000 70000 70000 70000											

For life-time calculation of rollers use our CD-ROM or homepage!

Formula: E

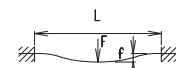
$$f = \frac{F \cdot L^3}{E \cdot I \cdot 192}$$

f = deflection (mm)
 F = load (N)
 L = free length (mm)
 E = elastic modulus 70000 (N/mm²)
 I = second moment of area (mm⁴)

Positioning system E 40, 60, 60S, 80, 80S

Dimensions (mm)

Increasing the carriage length will increase the basic length by the same amount.

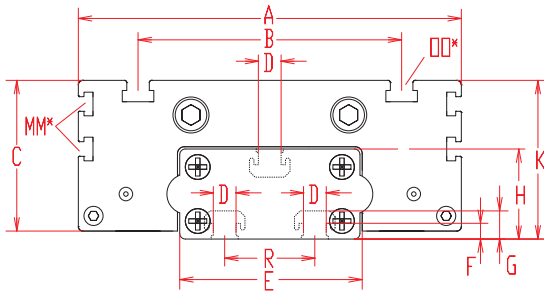

Size 80

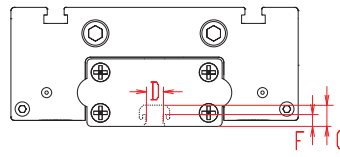

Size 40, 60

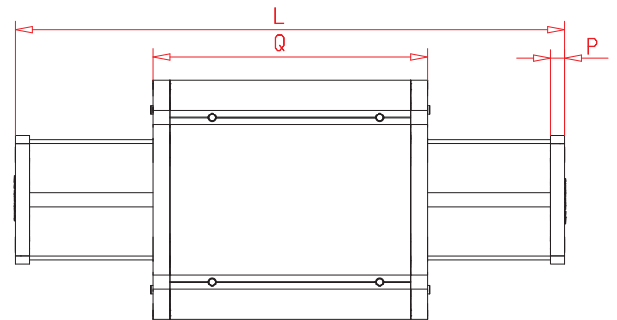
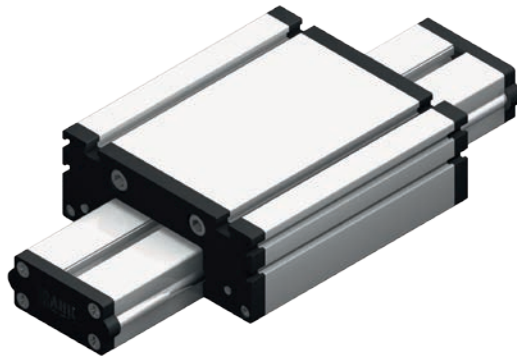

*For slide nuts refer to chapter 2.2 page 2

Size	Basic length L	A	B	C	D	E	F	G	H	K	MM for	OO for	P	Q	R	Basic weight	Weight per 100 mm
E 40	136	100	66	34,5	10	40	7	12,5	22	37	-	M 6	6	122	-	1,0 kg	0,13 kg
E 60	186	144	96	49	10	60	7	12,5	30	49	-	M 8	8	168	-	2,2 kg	0,20 kg
E 60S	212	170	108	53	10	60	7	12,5	30	53	-	M 8	8	194	-	3,2 kg	0,20 kg
E 80	215	170	117	66,5	10	80	7	12,5	40	70	M 6	M 10	10	194	40	3,4 kg	0,48 kg
E 80S	245	190	126	67,5	10	80	7	12,5	40	71	M 6	M 8	10	214	40	4,4 kg	0,48 kg

0 Choice of guide body profile:

- (0) Standard
- (2) corrosion-protected guide rods and screws
- (4) expanded corrosion-protected version (depending on the availability of components)

1500 Basic length + stroke = total length

E 40 0 0 0 0 0 0 0 0 1500 For combination kits and connecting elements refer to chapter 2.2

Sample ordering code:
E 40, non driven system, standard body profile, 1364 mm stroke

